

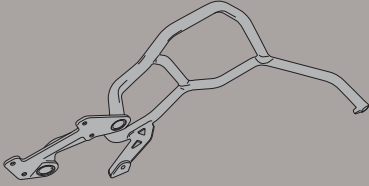





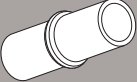

TN7703 - KN7703

PARAMOTORE SPECIFICO - SPECIFIC ENGINE GUARD - PARE-CARTER SPECIFIQUE SPEZIFISCHER STURZBÜGEL - DEFENSA DE MOTOR ESPECÍFICA - PARAMOTOR ESPECÍFICO

KTM 1190 ADVENTURE (2013)

N°	Descrizione	Caratteristiche	Codice	Quantità	
1	Paramotore - Engine Guard Pare-carter - Sturzbuegel Defensa De Moto - Paramotor	-	TN7703DXS TN7703SXS	2 (Dx,Sx)	
2	Supporto - Support - Support Halterung - Soporte - Apoio	-	GL2560S	4	
3	Supporto - Support - Support Halterung - Soporte - Apoio	-	Z2293	8	
4	Nipples	-	347TNG	1	
5	Guarnizione - Gasket Joint D'étanchéité - Dichtung Junta - Cobertura	-	Z2161	2	
6	Vite - Screw Vis - Schraube Tornillo - Parafuso	TCEI M8x40	840TCE	1	
7	Vite - Screw Vis - Schraube Tornillo - Parafuso	TE M10x95	1095TE	2	
8	Vite - Screw Vis - Schraube Tornillo - Parafuso	TBEI M6x55	655TBEI	8	
9	Rondella - Washer Rondelle - Scheibe Arandela - Arruela	Ø14 Foro 8mm	814RONZ	1	

TN7703 - KN7703

PARAMOTORE SPECIFICO - SPECIFIC ENGINE GUARD - PARE-CARTER SPECIFIQUE SPEZIFISCHER STURZBÜGEL - DEFENSA DE MOTOR ESPECÍFICA - PARAMOTOR ESPECÍFICO

KTM 1190 ADVENTURE (2013)

N°	Descrizione	Caratteristiche	Codice	Quantità	
10	Rondella - Washer Rondelle - Scheibe Arandela - Arruela	Ø10	10RON	2	
11	Rondella - Washer Rondelle - Scheibe Arandela - Arruela	-	6RONSX	8	
12	Distanziale - Spacer Entretoise - Distanzstueck Distanciador - Espaçador	Ø14x20 Foro 8.5mm	C14L20F8,5T	1	
13	Distanziale - Spacer Entretoise - Distanzstueck Distanciador - Espaçador	Ø18x25 Foro 10.5mm	C18L25F10,5T	2	
14	Distanziale - Spacer Entretoise - Distanzstueck Distanciador - Espaçador	Ø20x4 Foro 10.5mm	C20L4F10,5T	2	
15	Distanziale - Spacer Entretoise - Distanzstueck Distanciador - Espaçador	Ø22x6 Foro 10.5mm	C22L6F10,5T	2	
16	Componenti originali - Original parts Parties originales - Original bauteile Componentes originales - Componentes Originais	-	-	-	

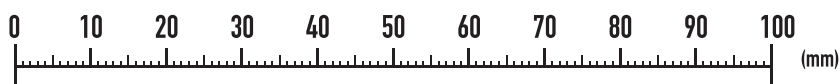
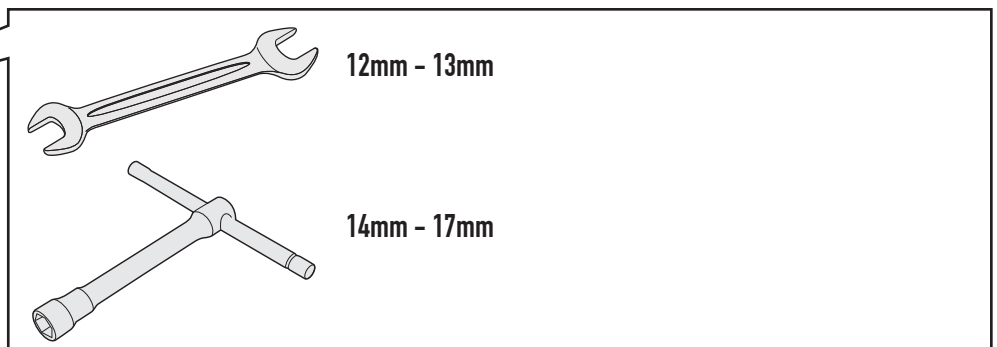
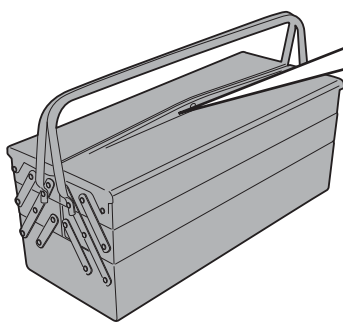

TN7703 - KN7703

PARAMOTORE SPECIFICO - SPECIFIC ENGINE GUARD - PARE-CARTER SPECIFIQUE SPEZIFISCHER STURZBÜGEL - DEFENSA DE MOTOR ESPECÍFICA - PARAMOTOR ESPECÍFICO

KTM 1190 ADVENTURE (2013)

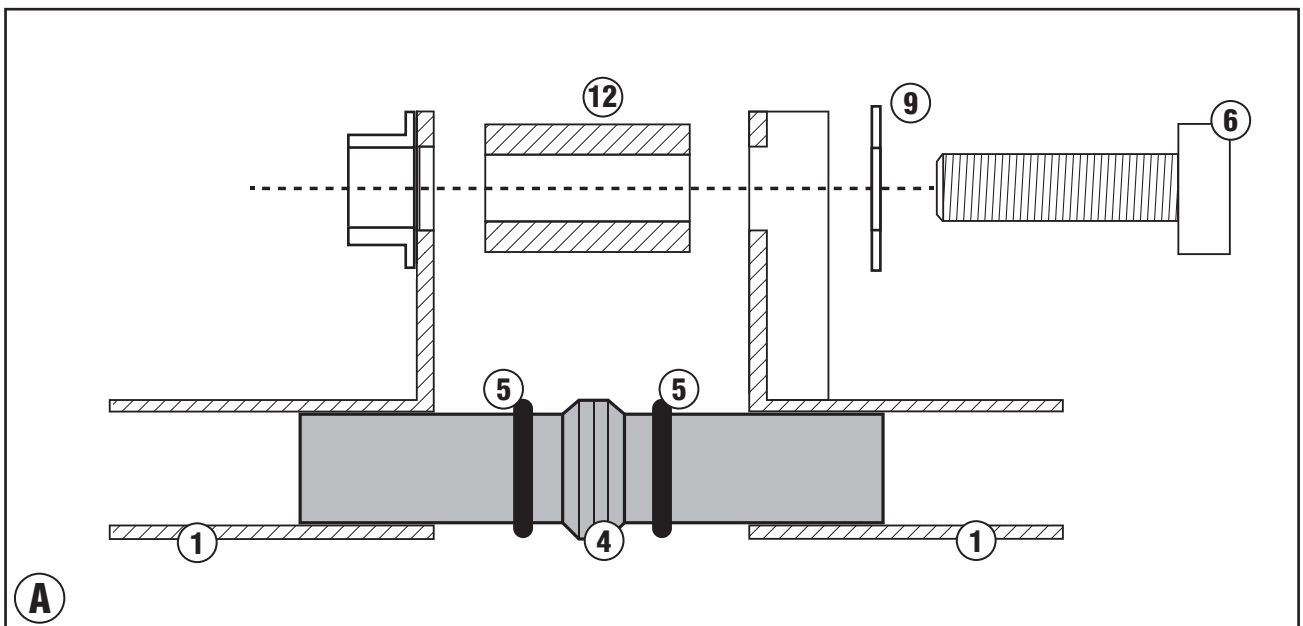
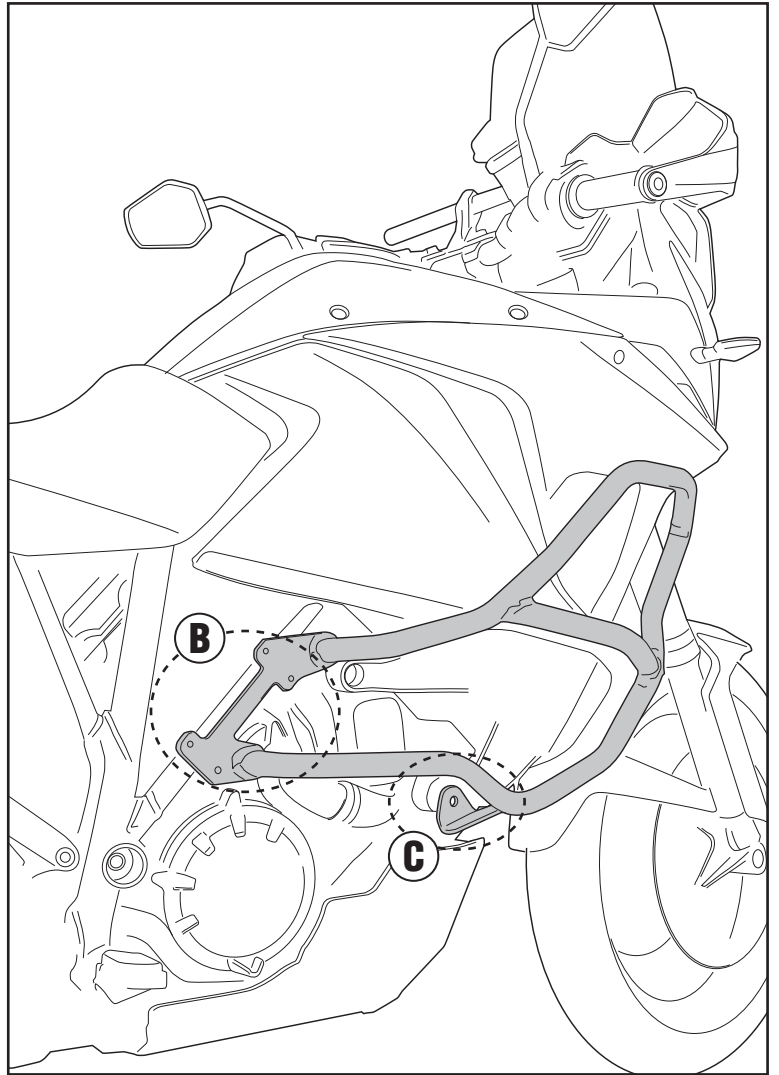
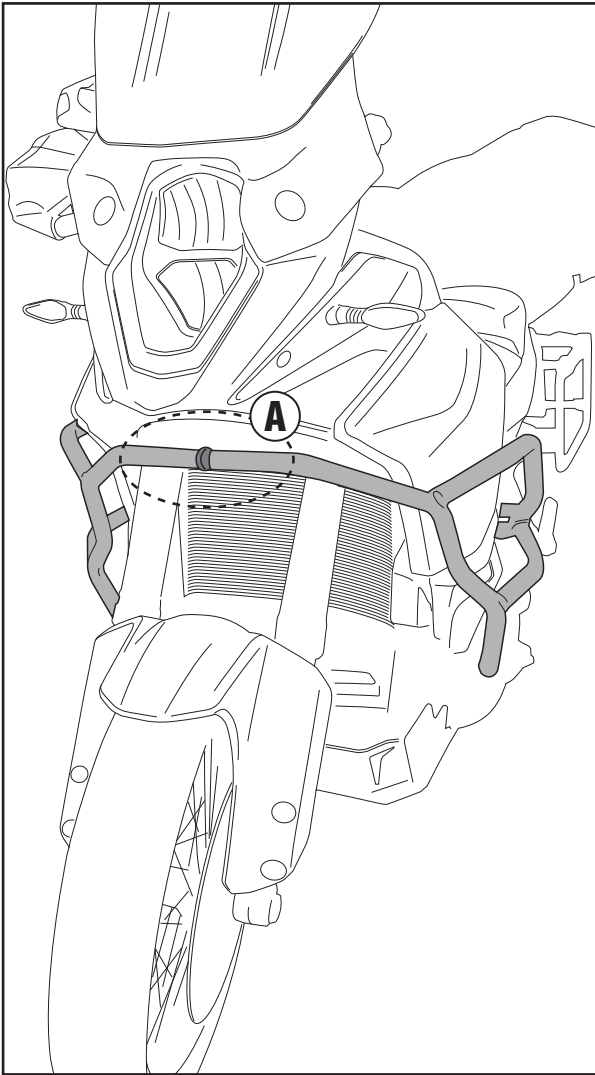

TN7703 - KN7703

PARAMOTORE SPECIFICO - SPECIFIC ENGINE GUARD - PARE-CARTER SPECIFIQUE SPEZIFISCHER STURZBÜGEL - DEFENSA DE MOTOR ESPECÍFICA - PARAMOTOR ESPECÍFICO

KTM 1190 ADVENTURE (2013)

